



Hi-Rel DC/DC CONVERTER MGDD-20 : 20W POWER

Hi-Rel
Grade ■ ■

12:1 Ultra Wide Input Dual Outputs Metallic Case - 1 500 VDC Isolation



- Ultra wide input range MIL-STD-1275D/E
- Nominal power up to 20 W
- Nominal dual output voltage from 5V to 48V
- High efficiency over the entire range (typ. 89%)
- Soft start
- Galvanic isolation 1.500 VDC according to EN 60950
- Integrated LC input filter
- Permanent short circuit protection
- External synchronisation
- External trim adjustment : -20/+10%
- No optocoupler for high reliability
- RoHS process

1-General

The MGDD-20 ultra wide input series designates a full family of DC/DC power modules with a permanent ultra wide input voltage range of 12-160 volts designed for use in distributed power architecture where variable input voltage for multiple battery and transient are prevalent making them ideal particularly for avionics and military applications.

Also the MGDD-20 is compliant with the stringent requirements of MIL-STD-1275E standard that requires systems to sustain any 2 Joules injected spike that may occurs in less than 1ms, while the previous revision MIL-STD-1275D imposed only 15 milliJoules injected spikes.

Thanks to its 160 V maximum input voltage, the MGDD-20 series allows designer to sustain the MIL-STD-1275E spike with the simplest additional protection device : a 100V or higher TVS.

The serie includes dual output voltage choices individually isolated of 2 x 5 volts , 2 x 12 volts, 2 x 15 volts and 2 x 24 volts with easy configurability. All the modules are designed with LC network filters to minimize reflected input current ripple. The modules include a soft-start, an input undervoltage lock-out, a permanent short circuit protection and an output overvoltage limitation to ensure efficient module protections. The soft-start allows current limitation and eliminates inrush current during start-up. The short circuit protection completely protects the modules against short-circuits of any duration by a shut-down and restores to normal when the overload is removed.

The modules are potted with a bi-component thermal conductive compound to ensure optimum power dissipation under harsh environmental conditions.

4

2-Product Selection

Dual output model : MGDD - 20 - - /

Input Voltage Range	
Permanent	Transient
R : 12-160 VDC	10,7 VDC / 1 s

Output
C : 2 x 5 VDC
E : 2 x 12 VDC
F : 2 x 15 VDC
I : 2 x 24 VDC

Options :

- /T : option for -55°C start up operating temperature
- /S : option for screening and serialization

2- Product Selection (continued)

Input range	Output	Current per Output	Reference	Options
12-160 VDC	2 x 5 VDC	2 A	MGDD-20-R-C	/T, /S
12-160 VDC	2 x 12 VDC	0,825 A	MGDD-20-R-E	/T, /S
12-160 VDC	2 x 15 VDC	0,65 A	MGDD-20-R-F	/T, /S
12-160 VDC	2 x 24 VDC	0,425 A	MGDD-20-R-I	/T, /S

Using various parallel or series connections of outputs, and the 80/110% trim capability, allows to cover almost the complete range of output voltages from 4V to 52V as shown in the table below.

Reference	Parallel Connection	Series Connection
MGDD-20-R-C	4 - 5,5 VDC	8 - 11 VDC
MGDD-20-R-E	9,6 - 13,2 VDC	19,2 - 26,4 VDC
MGDD-20-R-F	12 - 16,5 VDC	24 - 33 VDC
MGDD-20-R-I	19,2 - 26,4 VDC	38,4 - 52,8 VDC

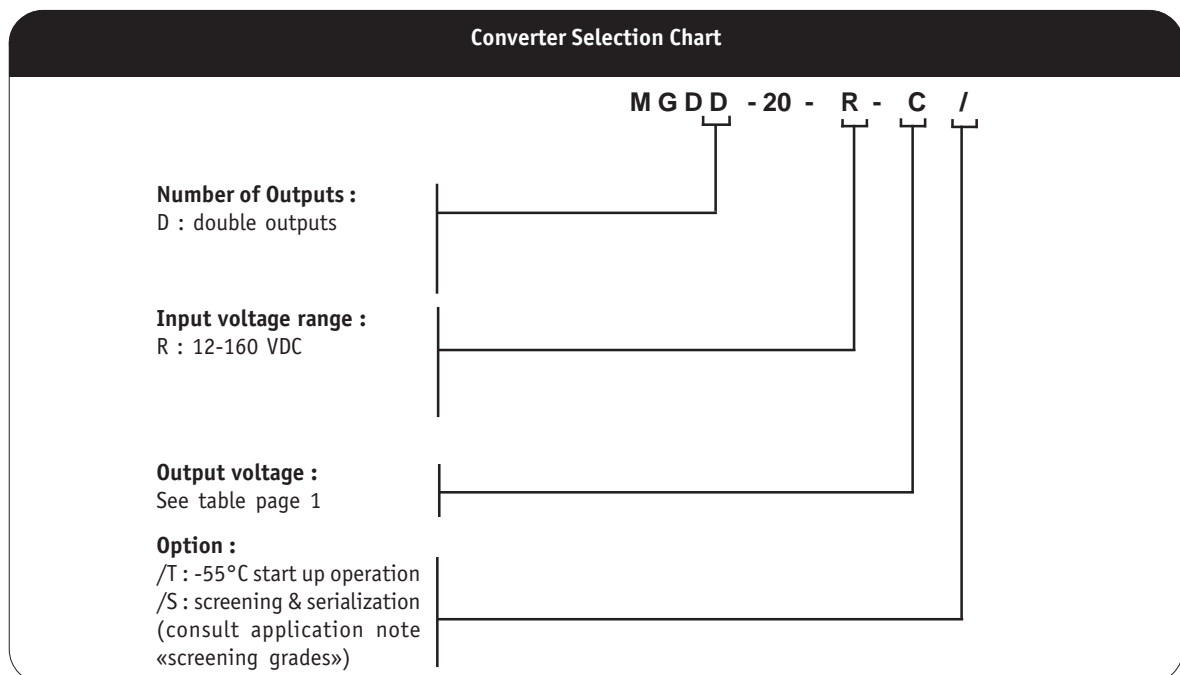

3- Electrical Specifications

Data are valid at +25°C, unless otherwise specified.

Parameter	Conditions	Limit or typical	Units	Dual Output MGDD-20 - R
Input				
Nominal input voltage	Full temperature range	Nominal	VDC	28
Permanent input voltage range (Ui)	Full temperature range Full load	Min. - Max.	VDC	12-160
Transient input voltage	Full load	Minimum	VDC/s	10,7 / 1
Undervoltage lock-out (UVLO)	Turn-on voltage	Maximum	VDC	11,8
	Turn-off voltage	Maximum	VDC	10,5
Start up time	Ui nominal within 3 ms Nominal output Full load : resistive	Maximum	ms	30
Reflected ripple current	Ui nominal, full load at switching freq. BW = 20MHz	Maximum	% Inom.	TBD
No load input power	Ui nominal No load	Maximum	W	1
Standby input power	Ui nominal	Maximum	W	1
Output				
Output voltage	Full temperature range	Nominal	VDC	2 x 5
	Ui min. to max.	Nominal	VDC	2 x 12
	75% load	Nominal	VDC	2 x 15
		Nominal	VDC	2 x 24
Set Point accuracy	Ambient temperature : +25°C Ui nominal, 75% load	Maximum	%	+/- 2
Total output power with both outputs	Full temperature range Ui min. to max.	Maximum	W	20
Output current per output	Full temperature range	Nominal	A	2,0
	Full load	Nominal	A	0,825
	Ui min. to max.	Nominal	A	0,65
	Nominal	A	0,425	
Unbalanced output	Minimum load on V01 for Vo2 proper operation	Typical	W	2
Ripple output voltage **	Ui nominal	Maximum	mVpp	100
	Full load	Maximum	mVpp	240
	BW = 20MHz	Maximum	mVpp	300
		Maximum	mVpp	520
Output regulation * (Line + load + thermal)	Ui min. to max. 0% to full load	Maximum	%	+/- 1,5
Cross load output regulation	Ui min. to max. V01 at nominal load V02 from 25% to full load	Maximum	%	+/-2
Output voltage trim	As a function of output voltage	Minimum	%	80
		Maximum	%	110
Maximum admissible capacitive load	Ui nominal	Maximum	μF	2 200
	Full load			
	Per output	Maximum	μF	820
	Maximum	μF	680	
24V output	Maximum	μF	470	
Efficiency	Ui nominal Full load	Typical	%	up to 89

Note * : Regulation is measured with both outputs in parallel configuration.

Note ** : The ripple output voltage is the periodic AC component imposed on the output voltage, an aperiodic and random component (noise) has also to be considered. This noise can be reduced by adding 1 external decoupling capacitor connected between Gin and Gout. These capacitance should be layed-out as close as possible from the converter. The ripple output voltage is measured by connecting a ceramic chip capacitor Co across Vo and Go pins (C=100μF if Vo<5Vdc C=10μF if Vo>5Vdc)

4- Electrical Characteristics (continued)

Typical Efficiency MGDD-20-R-C @ 25°C

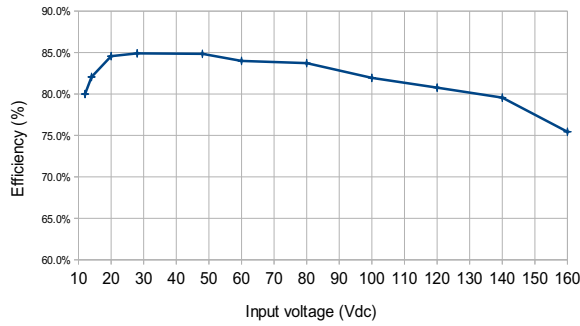

Typical Efficiency MGDD-20-R-E @ 25°C

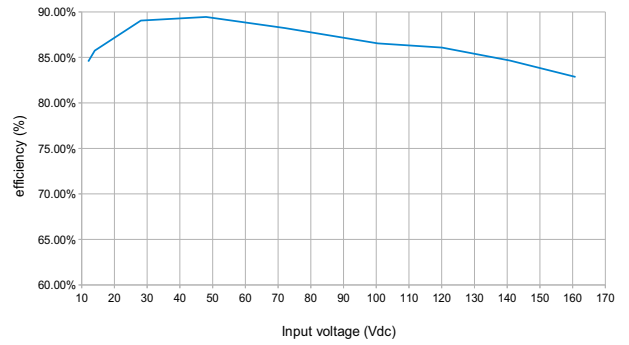

Typical Efficiency MGDD-20-R-F @ 25°C

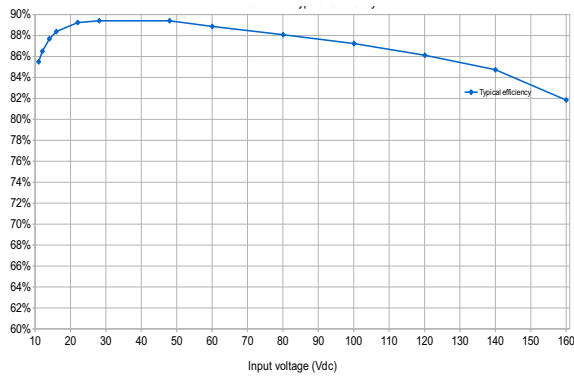

Typical Efficiency MGDD-20-R-I @ 25°C

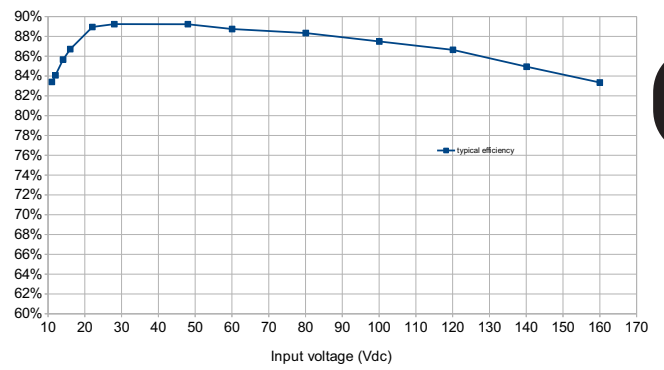

4- Switching Frequency

Parameter	Conditions	Limit or typical	Specifications
Switching frequency	Full temperature range Ui min. to max. No load to full load	Nominal, fixed	270 KHz

5- Isolation

Parameter	Conditions	Limit or typical	Specifications
Electric strength voltage	Input to output	Basic	1 500 VDC
	Between outputs	Functionnal	300 VDC
Isolation resistance	Input to case 500 VDC	Minimum	100 MOhm
	Output to case 500 VDC	Minimum	100 MOhm

6- Protection Functions

Characteristics	Protection Device	Recovery	Limit or typical	Specifications
Input undervoltage lock-out (UVLO)	Turn-on, turn-off circuit with hysteresis cycle	Automatic recovery	Turn-on nominal Turn-off nominal	See section 3
Output current limitation protection (OCP)	Straight line current limitation	Automatic recovery	Typical	130%
Output overvoltage protection (OVP)	Overvoltage protection limitation	Automatic recovery	Nominal	130% of output voltage

7- Reliability Data

Characteristics	Conditions	Temperature	Specifications
Mean Time Between Failure (MTBF) According to MIL-HDBK-217F	Ground fixed (Gf)	Case at 40°C Case at 70°C	618 000 Hrs 251 000 Hrs
	Airborne, Inhabited Cargo (AIC)	Case at 40°C Case at 85°C	Consult factory
Mean Time Between Failure (MTBF) According to IEC-62380-TR	Aircraft Civilian	Ambient at 25°C 100% time on	2 220 000 Hrs

8- Electromagnetic Interference and Surge

Electromagnetic Interference requirements according to MIL-STD-461D/E/F standards can be easily achieved as indicated in the following section. The following table resumes the different sections covered by these standards.

Standard Requirements	MIL-STD-461C Standard	MIL-STD-461D/E Standard	Compliance with GAIA Converter Module & common mode capacitance
Conducted emission (CE) : Low frequency High frequency	CE 01 CE 03	CE 101 CE 102	compliant module stand-alone compliant with additionnal filter
Conducted susceptibility (CS) : Low frequency High frequency	CS 01 CS 02	CS 101 CS114	compliant with additionnal filter compliant with additionnal filter
Radiated emission (RE) : Magnetic field Electrical field	RE 01 RE 02	RE 101 RE 102	compliant module stand-alone compliant module stand-alone
Radiated susceptibility (RS) : Magnetic field Electrical field	RS 01 RS 03	RS 101 RS 103	compliant module stand-alone compliant module stand-alone

8-1 Module Compliance with MIL-STD-461 Standards

To meet the latest US military standards MIL-STD-461 requirements and in particular the conducted noise emission CE102 (and also CE03) requirements, Gaïa Converter can propose an EMI filter module. In addition common mode capacitances C_{mc} (10nF/rated voltage depending on isolation requirement) connected between power pins and chassis or ground power-plane need to be implemented. When output channels are intended to be connected to load through long wire, it could be necessary to use additionnaly common mode inductors on each outputs. For a use at 28Vdc C7 can be rated to 47µF.

Please consult FGDS-series datasheets for further details.

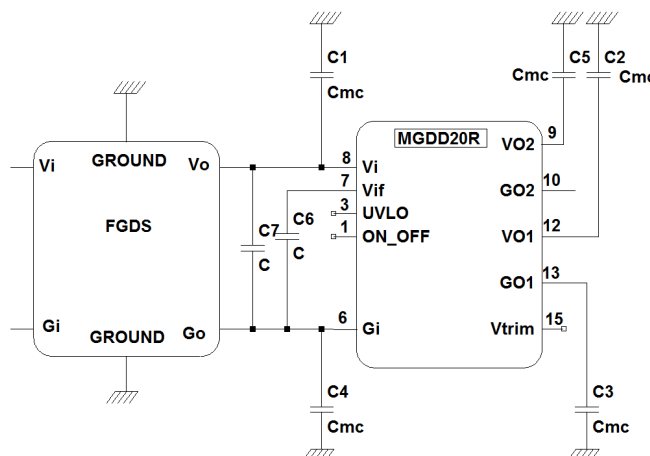

9- Thermal Characteristics

Characteristics	Conditions	Limit or typical	Performances
Operating ambient temperature range	Ambient temperature	Minimum Maximum	- 40°C see below
Operating case temperature range at full load	Case temperature	Minimum Maximum	- 40°C see curves hereafter
Storage temperature range	Non functioning	Minimum Maximum	- 55°C + 125°C
Thermal resistance	Rth case to ambient in free air natural convection	Typical	15°C /W

The following discussion will help designer to determine the thermal characteristics and the operating temperature.

Heat can be removed from the baseplate via three basic mechanisms :

- Radiation transfert : radiation is counting for less than 5% of total heat transfert in majority of case, for this reason the presence of radiant cooling is used as a safety margin and is not considered.
- Conduction transfert : in most of the applications, heat will be conducted from the baseplate into an attached heatsink or heat conducting member; heat is conducted thru the interface.
- Convection transfert : convecting heat transfer into air refers to still air or forced air cooling.

In majority of the applications, we will consider that heat will be removed from the baseplate either with :

- heatsink,
- forced air cooling,
- both heatsink and forced air cooling.

To calculate the maximum admissible ambient temperature the following method can be used.

Knowing the power used P_{out} and the efficiency η :

- determine the power dissipated by the module P_{diss} that should be evacuated :

$$P_{diss} = P_{out} / (\eta - 1) \quad (A)$$

- then determine the thermal dissipation :

$$T_{diss} = R_{th}(b-a) \times P_{diss} \quad (B)$$

where **$R_{th}(b-a)$** is the thermal resistance from the baseplate to ambient.

This thermal $R_{th}(b-a)$ resistance is the sum of :

- the thermal resistance of baseplate to heatsink (**$R_{th}(b-h)$**). The interface between baseplate and heatsink can be nothing or a conducting member, a thermal compound, a thermal pad.... The value of $R_{th}(b-h)$ can range from 0.4°C/W for no interface down to 0.1°C/W for a thermal conductive member interface.
- the thermal resistance of heatsink to ambient air (**$R_{th}(h-a)$**), which is depending of air flow and given by heatsink supplier.

The table hereafter gives some example of thermal resistance for different heat transfert configurations.

Heat transfert	Thermal resistance heatsink to air $R_{th}(h-a)$	Thermal resistance baseplate to heatsink $R_{th}(b-h)$	Global resistance
Free air cooling only	No Heatsink baseplate only :	15°C/W	No need of thermal pad
	BGA-STD-090 ABL Heatsink 10mm height	10°C/W	Including conductive adhesive pad
	SK551 Fischer Elektronik 12,3 mm height	11°C/W	Pad value to be added
Forced air cooling 400 LFM	BGA-STD-090 ABL Heatsink 10 mm width	5°C/W	Including conductive adhesive pad

9- Thermal Characteristics (continued)

The two formulas (A) and (B) described in previous page :

- $P_{diss} = P_{out}(1/\eta - 1)$ (A)
- $T_{diss} = R_{th}(b-a) \times P_{diss}$ (B)

conduct to determine the maximum ambient temperature admissible as a function of the maximum baseplate temperature of the module.

Knowing the maximum baseplate temperature $T_{max_baseplate}$ the maximum ambient temperature is given by the following formula :

$$T_a = T_{max_baseplate} - T_{diss} \quad (C)$$

MGDD-20-R-x Series Maximum Baseplate Temperature Versus % of Maximum Output Power

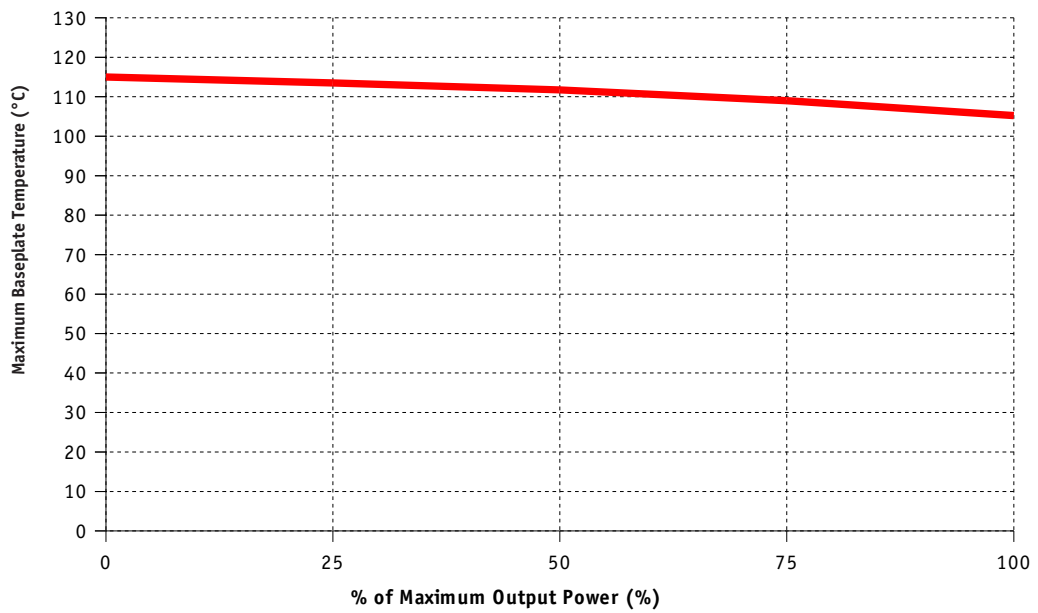

10- Environmental Qualifications

The modules have been subjected to the following environmental qualifications.

Characteristics	Conditions	Severity	Test procedure
Climatic Qualifications			
Life at high temperature	Duration Temperature / status of unit	Test D : 1 000 Hrs @ 105°C case, unit operating @ 125°C ambient, unit not operating	MIL-STD-202G Method 108A
Altitude	Altitude level C Duration Climb up Stabilization Status of unit	40 000 ft@-55°C 30 min. 1 000 ft/min to 70 000 ft@-55°C, 30 min. unit operating	MIL-STD-810E Method 500.3
Humidity cyclic	Number of cycle Cycle duration Relative humidity variation Temperature variation Status of unit	10 Cycle I : 24 Hrs 60 % to 88 % 31°C to 41°C unit not operating	MIL-STD-810E Method 507.3
Humidity steady	Damp heat Temperature Duration Status of unit	93 % relative humidity 40°C 56 days unit not operating	MIL-STD-202G Method 103B
Salt atmosphere	Temperature Concentration NaCl Duration Status of unit	35°C 5 % 48 Hrs unit not operating	MIL-STD-810E Method 509.3
Temperature cycling	Number of cycles Temperature change Transfert time Steady state time Status of unit	200 -40°C / +85°C 40 min. 20 min. unit operating	MIL-STD-202A Method 102A
Temperature shock	Number of shocks Temperature change Transfert time Steady state time Status of unit	100 -55°C / +105°C 10 sec. 20 min. unit not operating	MIL-STD-202G Method 107G
Mechanical Qualifications			
Vibration (Sinusoidal)	Number of cycles Frequency / amplitude Frequency / acceleration Duration Status of unit	10 cycles in each axis 10 to 60 Hz / 0.7 mm 60 to 2 000 Hz / 10 g 2h 30 min. per axis unit not operating	MIL-STD-810D Method 514.3
Shock (Half sinus)	Number of shocks Peak acceleration Duration Shock form Status of unit	3 shocks in each axis 100 g 6 ms 1/2 sinusoidal unit not operating	MIL-STD-810D Method 516.3
Bump (Half sinus)	Number of bumps Peak acceleration Duration Status of unit	2 000 Bumps in each axis 40 g 6 ms unit not operating	MIL-STD-810D Method 516.3

11- Description of Protections

The MGDD-20 series includes 3 types of protection devices.

11-1 Input Undervoltage Lockout (UVLO)

An input undervoltage protection will inhibit the module when input voltage drops below the lock-out turn-off threshold (see section 3 for value) and restores to normal operation automatically when the input voltage rises the lock-out turn-on threshold.

The UVLO voltage can be adjusted using a resistor (R_{uvlo}) connected between pin 3 and G_i . This value can be adjusted in order to allow converter to stop properly accordingly to the input bus (or battery) voltage value. The R_{uvlo} can be determined using the following formula :

$$R_{uvlo} (K\Omega) = 187 / [V_{uvlo} - 11]$$

R_{uvlo} = trimming resistance
 V_{uvlo} = desire turn-on voltage

Without resistor, the turn on voltage is 11.8V and turn off voltage is 10.5V

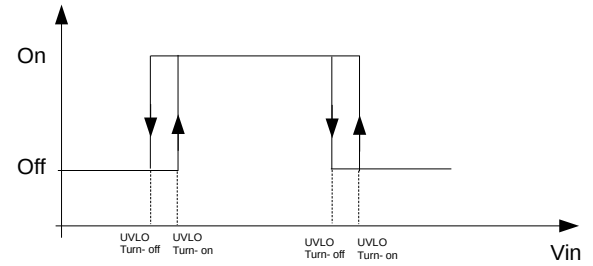
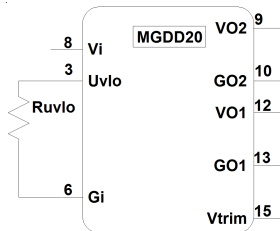

U_{Mo} Voltage trimming

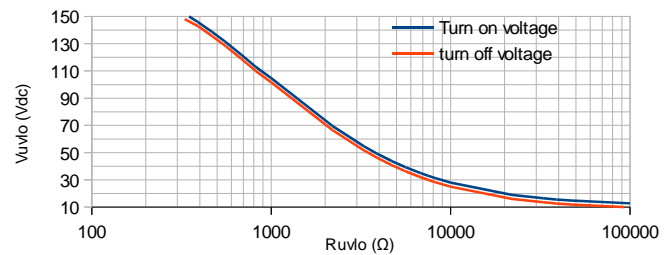

11-2 Output Over Current Limitation Protection (OCP)

The MGDD-20 Series incorporates a overcurrent protection circuit. The overcurrent protection detects short circuit or over current and protects the module according to the hiccup graph. The maximum detection current I_d is depending on input voltage V_{in} , temperature, and is higher than 105 % maximum nominal output current.

When OCP is triggered, the converter falls in hiccup mode by testing periodically if the overload is still present. The module restart automatically to normal operation when overcurrent is removed. T_d (detection time) and T_h (hiccup period) are depending on V_{in} and temperature. In hiccup mode the average current is around 25 % of I_{nom} .

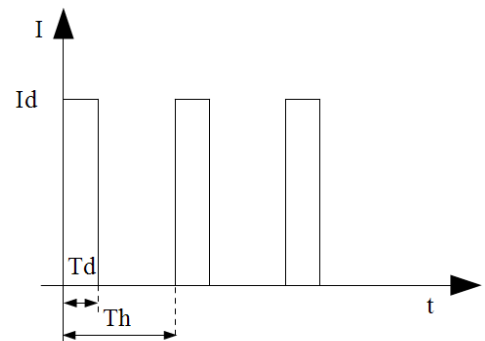

11-3 Output Overvoltage Protection (OVP)

The MGDD-20 series has an internal overvoltage limitation protection circuit that monitors the voltage across the output power terminals. It is designed to limit the converter output voltage to 130% (+/-10%) of nominal output voltage.

12- Description of Functions

12-1 Connection of Outputs

The outputs of MGDD-20 can be connected in various configurations such as :

- connections in series
- connection in parallel
- connection in symmetry
- connection in independence

Please note that regulation is achieved through output VO1/GO1 referenced as primary output. When connected in symetrie or independent configurations with unbalanced loads, VO1/GO1 has to be loaded at 2W minimum to insure proper operating of the converter. The VO2/GO2 output referenced as secondary output may stay unloaded, but in that case its regulation may drift up as shown in curve below. There is no minimum load when the two outputs are connected in parallel or balanced serie.

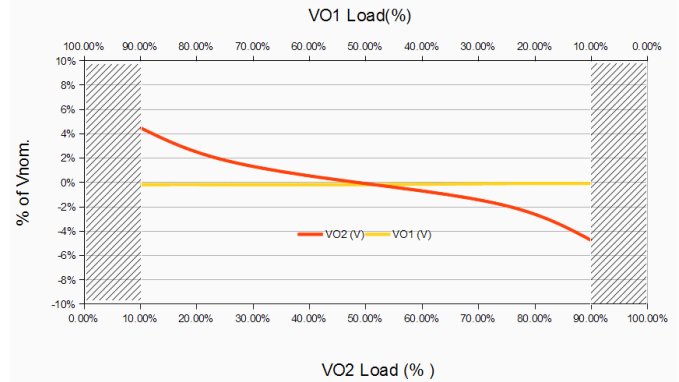
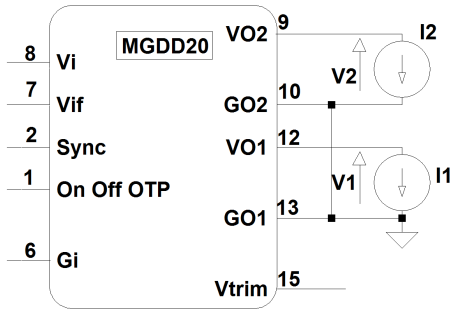

12-1-1 Connection of Outputs in Series

Outputs connected in series allow to achieve 10V, 24V, 30V or 48V output voltages up to 20W total power. These values can be extended using trim adjustment.

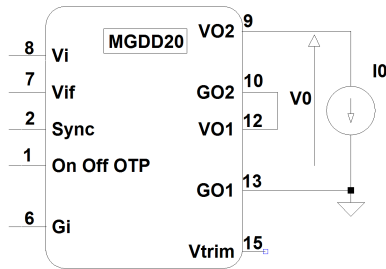

13-1-2 Connection of Outputs in Parallel

Outputs connected in paralell allow to achieve single output 5V, 12V, 15V or 24V up to 20W power. These values can be extended using trim adjustment.

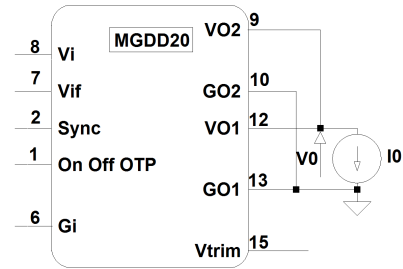

12-1-3 Connection of Outputs in Symmetry

Outputs connected in symetrie allow to achieve +/-5V, +/-12V, +/-15V or +/-24V voltages (+/-10W each) with possible unbalanced load up to 17W on primary output, 3W on secondary output and vice versa.

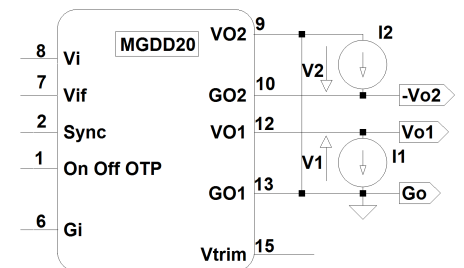

12-1-4 Connection of Outputs in Independence

Outputs connected independantly with floating DC between each other can be achieved for 2x5V, 2x12V, 2x15V or 2x24V voltages (10W each) with possible unbalanced load up to 17W on primary output 3W on secondary output and vice versa.

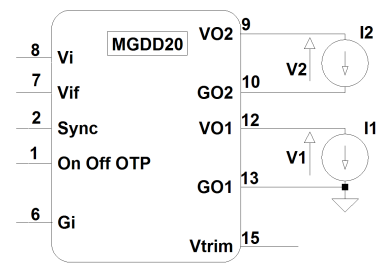
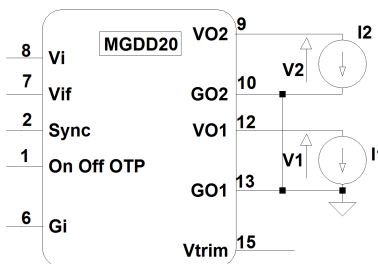

12- Description of Functions (continued)

12-2 Trim Function

The output voltage Vo1 may be trimmed in a range of 80%/110% of the nominal output voltage via a single external trimpot or fixed resistor.

The Vo2 output will automatically follow output Vo1.

Trim Up Function

Do not attempt to trim the module higher than 110% of nominal output voltage as the overvoltage protection may occur.

Also do not exceed the maximum rated output power when the module is trimmed up.

The trim up resistance must be calculated with the following formula :

$$R_u (k\Omega) = \frac{(R1 * VO_{nom} * (VO - V_{ref}))}{((VO - VO_{nom}) * V_{ref})} - R1 - R2$$

Trim Down Function

Do not trim down more than -20% of nominal output voltage otherwise the module may be damaged.

The available output power is reduced by the same percentage that output voltage is trimmed down.

The trim down resistance must be calculated with the following formula :

$$R_d (k\Omega) = \frac{((R1 + R2) * VO - (R2 * VO_{nom}))}{(VO_{nom} - VO)}$$

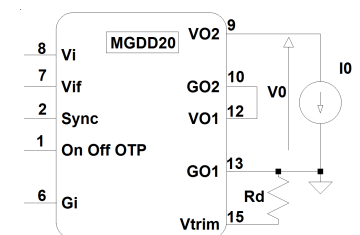
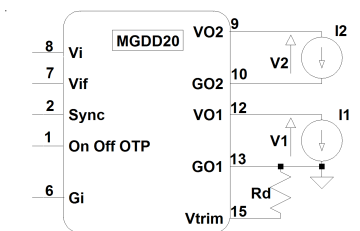
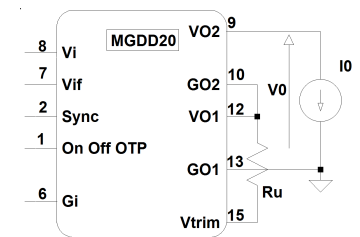
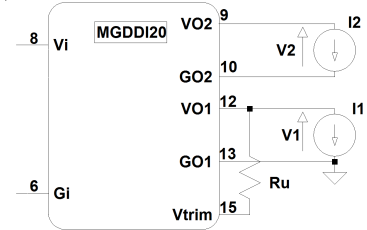

Parameter	Unit	Min.	Typ.	Max.
Trim reference Vref	Vdc	1,2	1,225	1,25
Resistor R1	Ohm	/	3,9K	/
Resistor R2	Ohm	/	270	/
Trim capacitor C	nF	/	TBD	/

12- Description of Functions (continued)

12-3 On/Off Function

The control pin 1 (On/Off) can be used for applications requiring On/Off operation. This may be done with an open collector transistor, a switch, a relay or an optocoupler. Several converters may be disabled with a single switch by connecting all On/Off pins together.

- The converter is disabled by pulling low the pin 1.
- No connection or high impedance on pin 1 enables the converter.

By releasing the On/Off function, the converter will restart within the start up time specifications given in table section 3

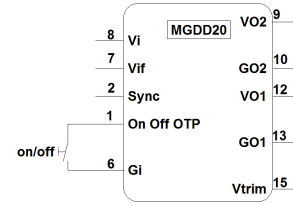

Parameter	Unit	Min.	Typ.	Max.	Notes, conditions
On/Off module enable voltage	Vdc	2.5	/	3.0	Open, the switch must not sink more than 50µA
On/Off module disable voltage	Vdc	0	/	0.5	The switch must be able to sink 0,5mA
On/Off module enable delay	ms	/	/	30	The module restarts with the same delay after alarm mode removed
On/Off module disable delay	µs	/	/	100	Vi nominal, full load

12-4 Synchronization (SYNC)

The «Sync» pin allows the synchronization of a module to an external frequency source or to another MGDD-20 module. The pin is bidirectionnal and must be driven by an open drain circuitry providing a square wave signal (active on falling edge) with a frequency ranging between 285kHz to 310kHz. Higher frequency synchronization is possible, please consult factory. The characteristics of the signal are detailed in the figure hereunder : ($t_r, t_f < 30ns$; $100ns < T_p < 400ns$)

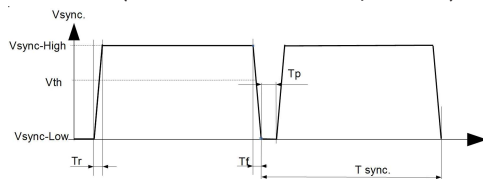
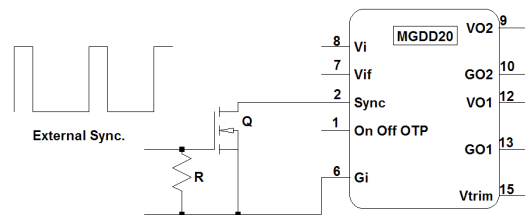

12-5 Input Filter Compensation (VIF)

The «VIF» pin is a direct access to the capacitor of the LC input filter and allows to increase the C value to enhance the converter's stability and performance and to reduce the input current ripple for improved EMI performance. It is recommended to provide low ESR ceramic capacitors, total value can range from 2.2µF for high input voltage use to 10µF for low input voltage use. These capacitors should have the proper voltage rating. Because of high current flowing through it, it should be connected between «VIF» and «Gin» as close as possible from the converter, using large copper traces.

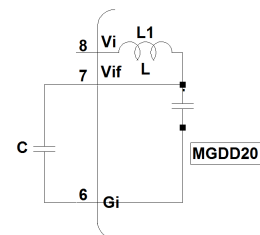

13- Dimensions

Dimension are given in mm. Tolerance : +/- 0,2 mm (+/- 0.01 ") unless otherwise indicated.
Weight : 35 grams (1.25 Ozs) max.

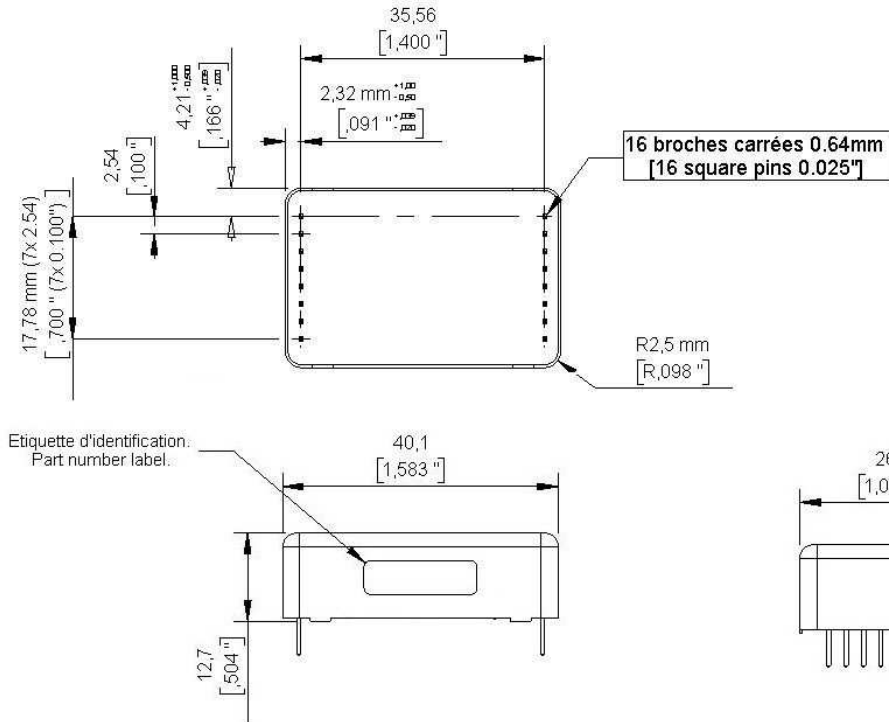

14- Materials

Case : Metallic black anodized coating.
Pins : Flash gold plating over nickel underplate.

15- Product Marking

Upper face : Company logo.
Side face : Module reference, option, date code : year and week of manufacturing.

16- Connections

The MGD-20 series has been designed for on-board mounting.
it is recommended not to lay-out any component under the module.

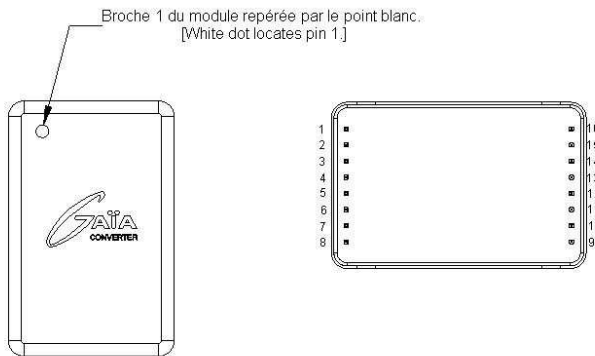

Pin	Single
1	On/Off
2	Sync
3	UVLO
4, 5	Do not connect
6	- Input (Gi)
7	VIF
8	+ Input (Vi)
9	+ Output 2 (Vo2)
10	- Output 2 (Go2)
11	Do not connect
12	+ Output 1 (Vo1)
13	- Output 1 (Go1)
14	Do not connect
15	Vtrm
16	Do not connect



Represented by :

Information given in this datasheet is believed to be accurate and reliable. However, no responsibility is assumed for the consequence of its use nor for any infringement of patents or other rights of third parties which may result from its use. These products are sold only according to GAIA Converter general conditions of sale, unless otherwise confirmed by writing. Specifications subject to change without notice.