



Hi-Rel DC/DC CONVERTER MGDD-40 : 40W POWER

Hi-Rel
Grade ■ ■

8:1 Ultra Wide Input Dual Outputs Metallic Case - 1 500 VDC Isolation



4

- Ultra wide input range 4,5-33 VDC & 9-60 VDC
- Nominal power up to 40 W
- Maximum power per channel up to 34W
- Nominal dual output voltage from 3,3V to 48V
- High efficiency over the entire range (typ. 89%)
- Soft start
- Galvanic isolation 1.500 VDC
- Integrated LC input filter
- Permanent short circuit protection
- External synchronisation
- External trim adjustment : -20/+10%
- No optocoupler for high reliability
- RoHS process

1-General

The MGDD-40 ultra wide input series designates a full family of DC/DC power modules with a permanent ultra wide input voltage range of 4,5-33 volts and 9-60 volts. The family is designed for use in distributed power architecture where variable input voltage and transient are prevalent making them ideal particularly for avionics and military applications.

The MGDD-40 is ideal for applications where high power density up to 40W/inch³ is required.

The MGDD-40 series is compliant with DO-160 and MIL-STD-704 transient voltage without additional voltage limiter.

The serie includes dual output voltage choices individually isolated of 2 x 3,3 volts , 2 x 5 volts , 2 x 12 volts, 2 x 15 volts and 2 x 24 volts and double 5 & 12 volts all with easy configuration in series, parallel, symmetry.

The total power is 40W with one single channel

able to provide up to 34W in load unbalanced mode.

All the modules are designed with LC network filters to minimize reflected input current ripple. The modules include a soft-start, an input undervoltage lock-out, a permanent short circuit and overload protection and an output overvoltage limitation to ensure efficient module protections. The soft-start allows current limitation and eliminates inrush current during start-up. The short circuit protection completely protects the modules against short-circuits of any duration by a shut-down and restores to normal when the overload is removed.

The modules are potted with a bi-component thermally conductive compound to ensure optimum power dissipation under harsh environmental conditions.

2-Product Selection

Dual output model : MGDD - 40 - - /

Input Voltage Range

	Permanent	Transient
N :	9-60* VDC	80 VDC / 1 s
E :	4,5-33 VDC	45 VDC / 0.1 s

* 75VDC permanent (consult factory)

Output

B : 2 x 3,3 VDC
 C : 2 x 5 VDC
 E : 2 x 12 VDC
 F : 2 x 15 VDC
 I : 2 x 24 VDC
 CE : 5 VDC and 12 VDC

Options :

/T : option for -55°C start up operating temperature
 /S : option for screening and serialization

2- Product Selection (continued)

Input range	Output	Current per Output	Reference	Options
4.5-33 VDC	2 x 3,3 VDC	4 A	MGDD-40-E-B	/T, /S
4.5-33 VDC	2 x 5 VDC	4 A	MGDD-40-E-C	/T, /S
4.5-33 VDC	2 x 12 VDC	1,65 A	MGDD-40-E-E	/T, /S
4.5-33 VDC	2 x 15 VDC	1,30 A	MGDD-40-E-F	/T, /S
4.5-33 VDC	2 x 24 VDC	0,85 A	MGDD-40-E-I	/T, /S
9-60 VDC	2 x 3,3 VDC	4 A	MGDD-40-N-B	/T, /S
9-60 VDC	2 x 5 VDC	4 A	MGDD-40-N-C	/T, /S
9-60 VDC	2 x 12 VDC	1,65 A	MGDD-40-N-E	/T, /S
9-60 VDC	2 x 15 VDC	1,30 A	MGDD-40-N-F	/T, /S
9-60 VDC	2 x 24 VDC	0,85 A	MGDD-40-N-I	/T, /S
9-60 VDC	5 VDC and 12 VDC	4A and 1,65A	MGDD-40-N-CE	/T, /S

Using various parallel or series connections of outputs, and the 80/110% trim capability (100/110% for 3,3 V output), allows to cover almost the complete range of output voltages from 3,3V to 52V as shown in the table below.

Reference	Parallel Connection	Series Connection	Symmetrical Connection
MGDD-40-E-B	3,3 - 3,6 VDC	6,6 - 7,3 VDC	+/-3,3 - +/-3,6 VDC
MGDD-40-E-C	4 - 5,5 VDC	8 - 11 VDC	+/-4 - +/-5,5 VDC
MGDD-40-E-E	9,6 - 13,2 VDC	19,2 - 26,4 VDC	+/-9,6 - +/-13,2 VDC
MGDD-40-E-F	12 - 16,5 VDC	24 - 33 VDC	+/-12 - +/-16,5 VDC
MGDD-40-E-I	19,2 - 26,4 VDC	38,4 - 52,8 VDC	+/-19,2 - +/-26,4 VDC
MGDD-40-N-B	3,3 - 3,6 VDC	6,6 - 7,3 VDC	+/-3,3 - +/-3,6 VDC
MGDD-40-N-C	4 - 5,5 VDC	8 - 11 VDC	+/-4 - +/-5,5 VDC
MGDD-40-N-E	9,6 - 13,2 VDC	19,2 - 26,4 VDC	+/-9,6 - +/-13,2 VDC
MGDD-40-N-F	12 - 16,5 VDC	24 - 33 VDC	+/-12 - +/-16,5 VDC
MGDD-40-N-I	19,2 - 26,4 VDC	38,4 - 52,8 VDC	+/-19,2 - +/-26,4 VDC

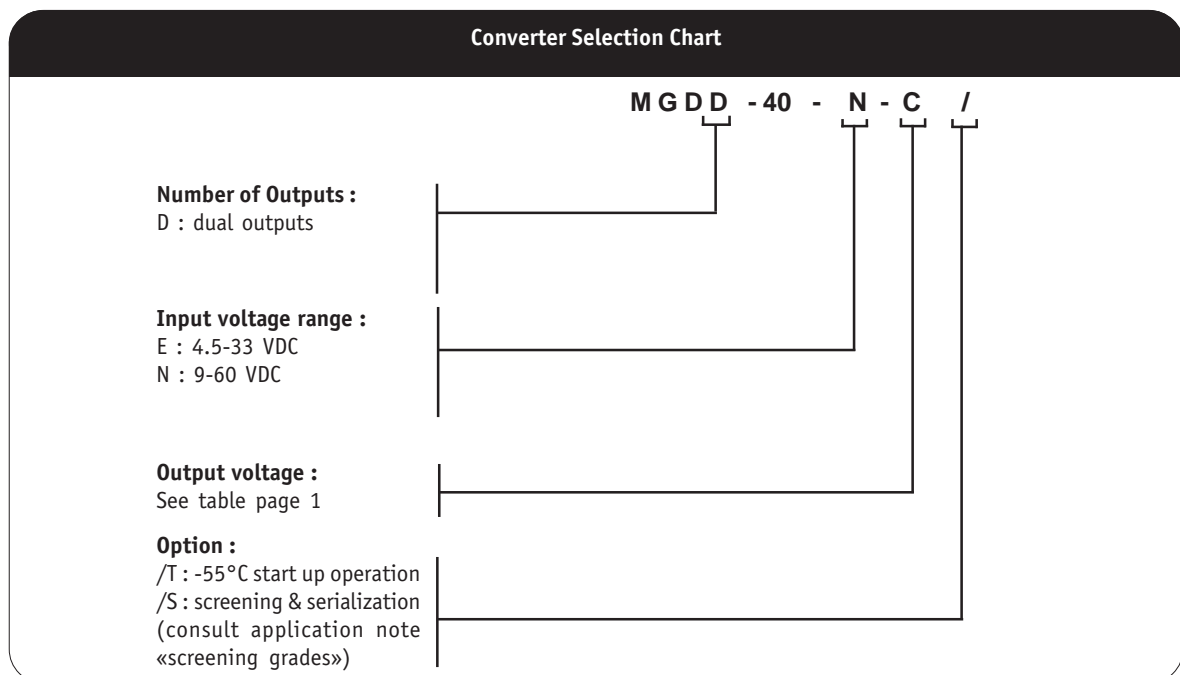

3- Block Diagram and Pin Description

The MGDD-40 is based on a new generation platform with a new topology allowing ultra wide input range up to 4,5-33 VDC and 9 to 60 VDC input voltage. The double output combined to the trim function allows multiple combinations to achieves most of the

common voltages i.e 3,3V-5V-9V-10V-12V-15V-24V-28V-30V-32V-48V-52V, and more over. The MGDD-40 module block diagram and pin description are presented hereafter.

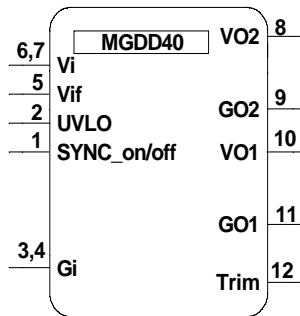
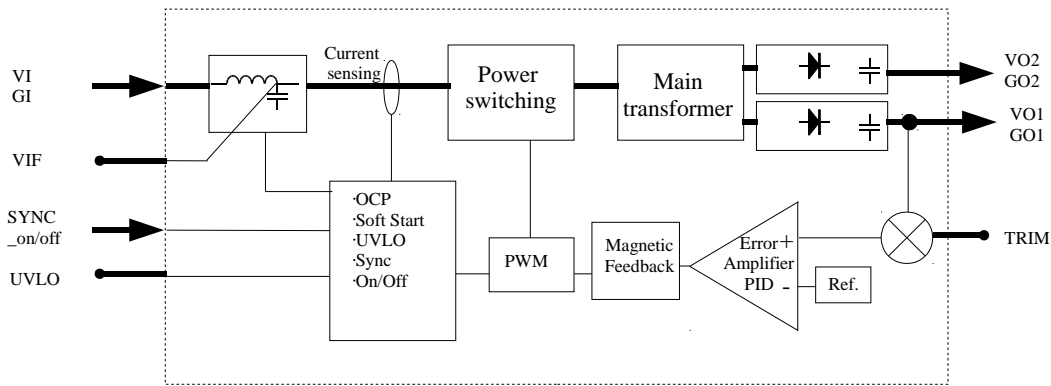

Pin Description :

UVLO : this pin allows to user to increase the UVLO (Under voltage Lock out) threshold value, in order to stop converter operation when input voltage reaches a given value.

GI : Input bus return lead.

VIF : This pin gives direct access to input filter capacitor that improves EMI performance.

VI : Input bus lead.

SYNC_On/Off : this pin is an input pin that allows user to synchronize to an external signal. See chapter synchronization for sync signal application. Connecting this pin to GI acts as an on/off function, shutting down the converter.

GO2 : return terminal of output number 2.

VO2 : output number 2 terminal.

GO1 : return terminal of output number 1.

VO1 : output number 1 terminal. The output number 1 is considered as the main output, and must be mandatory loaded.

TRIM : output voltage trimming input.

4- Electrical Specifications

Data are valid at +25°C, unless otherwise specified.

Parameter	Conditions	Limit or typical	Units	Dual Outputs	
				MGDD-40 - E	MGDD-40 - N
Input					
Nominal input voltage	Full temperature range	Nominal	VDC	12	28
Permanent input voltage range (Ui)	Full temperature range Full load	Min. - Max.	VDC	4.5-33	9-60
Extended permanent input voltage range (Ui)	Consult factory Depends on reference	Min. - Max.	VDC	4.5-33	9-75
Transient input voltage	Full load	Minimum	VDC/s	45 / 0.1	80 / 1
Absolute max. input voltage	Power off	Maximum	VDC/s	50	100 / 0.1
Undervoltage lock-out (UVLO) Pin UVLO not connected	Turn-on voltage Hysteresis	Nominal	VDC	4.5	9
		Nominal	VDC	0.5	1
Undervoltage lock-out range	Trim range	Nominal	VDC	4.5-Vi max.	9- Vin max.
Start up time on power-up	Ui nominal, full load resistive	Maximum	ms	30	30
Start up time on SD release	Ui nominal, full load resistive	Maximum	ms	30	30
Reflected ripple current	Ui nominal, full load at switching freq. BW = 20MHz 1µF on Vif, 33µF on Vin	Maximum	% Inom.	10	10
No load input power	Ui nominal No load	Nominal	W	0.5	0.5
Standby input power	Ui nominal	Nominal	W	0.3	0.3
Output					
Output voltage		Nominal	VDC	2 x 3.3	2 x 3.3
		Nominal	VDC	2 x 5	2 x 5
		Nominal	VDC	2 x 12	2 x 12
		Nominal	VDC	2 x 15	2 x 15
		Nominal	VDC	2 x 24	2 x 24
Set Point accuracy	Ambient temperature : +25°C Ui nominal, 75% load	Maximum	%	+/- 2	+/- 2
Total output power with both outputs loaded	Full temperature range Ui min. to max.	Maximum	W	40 (26.5 for 3.3V output)	40 (26.5 for 3.3V output)
Maximum power per channel	Full temperature range Ui min. to max.	Maximum	W	34 (24 for 3.3V output)	34 (24 for 3.3V output)
Output current per output	Full temperature range	Nominal	A	4.00	4.00
12V output	Full load see note (1)	Nominal	A	1.65	1.65
15V output	Ui min. to max.	Nominal	A	1.30	1.30
24V output		Nominal	A	0.85	0.85
Ripple output voltage **					
5V & 3.3V output	Ui nominal	Maximum	mVpp	150	150
12V output	Full load	Maximum	mVpp	240	240
15V output	BW = 20MHz	Maximum	mVpp	300	300
24V output		Maximum	mVpp	500	500
Output regulation * (Line + load + thermal)	Ui min. to max. 0% to full load	Maximum	%	+/- 2	+/- 2
Cross load output regulation	Ui nom V01 at nominal load V02 at 25% load	Maximum	%	+10/-2	+10/-2
Output voltage trim	As a function of output voltage	Minimum	%	80	80
		Maximum	%	110	110
Maximum admissible capacitive load					
5V & 3,3V output	Ui nominal	Maximum	µF	2 000	2 000
12V output	Full load	Maximum	µF	1 000	1 000
15V output	Per output	Maximum	µF	700	700
24V output		Maximum	µF	470	470
Efficiency	Ui nominal Full load	Typical	%	up to 89	up to 89

Note * : Regulation is measured with both outputs in parallel configuration.

Note ** : The ripple output voltage is the periodic AC component imposed on the output voltage, an aperiodic and random component (noise) has also to be considered. This noise can be reduced by adding 1 external decoupling capacitor connected between Gin and Gout. These capacitance should be layed-out as close as possible from the converter. The ripple output voltage is measured by connecting a ceramic chip capacitor Co across Vo and Go pins (C=100µF if Vo<5Vdc C=10µF if Vo>5Vdc)

4- Electrical Specifications

Data are valid at +25°C, unless otherwise specified.

Parameter	Conditions	Limit or typical	Units	Double Outputs MGDD-40-N-CE
Input				
Nominal input voltage	Full temperature range	Nominal	VDC	28
Permanent input voltage range (Ui)	Full temperature range Full load	Min. - Max.	VDC	9-60
Extended permanent input voltage range (Ui)	Consult factory Depends on reference	Min. - Max.	VDC	9-75
Transient input voltage	Full load	Minimum	VDC/s	80 / 1
Absolute max. input voltage	Power off	Maximum	VDC	100
Undervoltage lock-out (UVLO)	Turn-on voltage	Nominal	VDC	9
Pin UVLO not connected	Hysteresis	Nominal	VDC	1
Undervoltage lock-out range	Trim range	Nominal	VDC	9- Vin max.
Start up time on power-up	Ui nominal, full load resistive	Maximum	ms	30
Start up time on SD release	Ui nominal, full load resistive	Maximum	ms	30
Reflected ripple current	Ui nominal, full load at switching freq. BW = 20MHz 1µF on Vif, 33µF on Vin	Maximum	% Inom.	10
No load input power	Ui nominal No load	Nominal	W	0.35
Standby input power	Ui nominal	Nominal	W	0.03
Output				
Output voltage		Nominal	VDC	5 and 12
Set Point accuracy on primary output Vo1 (5V)	Ambient temperature : +25°C Ui nominal, 75% load	Maximum	%	+/- 2
Total output power with both outputs loaded	Full temperature range Ui min. to max.	Maximum	W	40
Maximum unbalanced power per channel	Full temperature range Ui min. to max.	Maximum	W	30
Output current per output	Full temperature range			
Vo1 : 5V output	Full load	Nominal	A	4,0
Vo2 : 12V output	Ui min. to max.	Nominal	A	1,65
Ripple output voltage **	Ui nominal	Maximum	mVpp	150
Vo1 : 5V output	Full load	Maximum	mVpp	240
Vo2 : 12V output	BW = 20MHz			
Primary output Vo1 regulation (Line + load + thermal)	Ui min. to max. 0% to full load	Maximum	%	+/- 2
Secondary Output Vo2 regulation (Line + load + thermal)	Ui min. to max. with Vo1 > 25% load	Maximum	%	+/- 5
Cross load output regulation	Ui min. to max.	Maximum	%	see section 13.1
Output voltage trim	As a function of output voltage	Minimum Maximum	% %	80 110
Maximum admissible capacitive load	Ui nominal			
5V output	Full load	Maximum	µF	2 000
12V output	Per output	Maximum	µF	1000
Efficiency	Ui nominal, Full load	Typical	%	86

Note **: The ripple output voltage is the periodic AC component imposed on the output voltage, an aperiodic and random component (noise) has also to be considered. This noise can be reduced by adding 1 external decoupling capacitor connected between Gin and Gout. These capacitance should be layed-out as close as possible from the converter. The ripple output voltage is measured by connecting a ceramic chip capacitor Co across Vo and Go pins (C=100µF if Vo<5Vdc C=10µF if Vo>5Vdc)

4- Electrical Characteristics (continued)

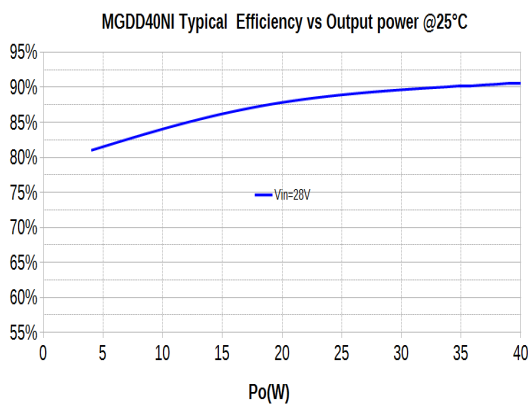
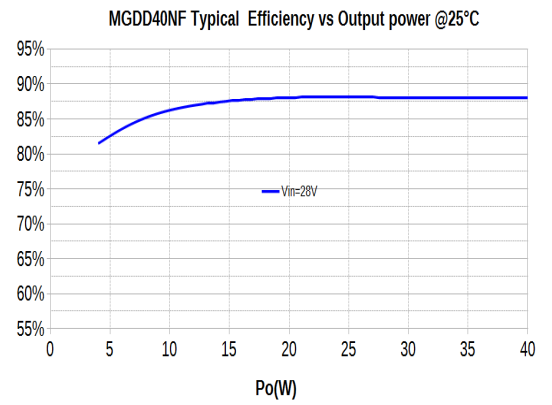
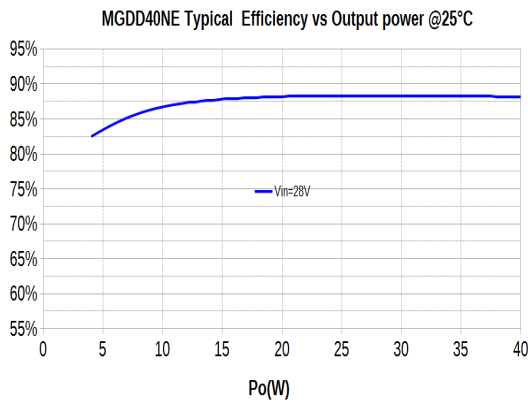
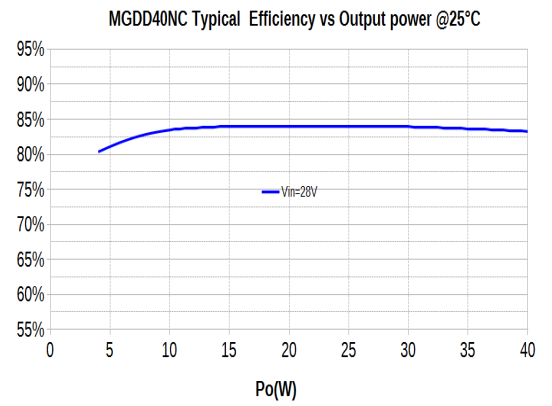
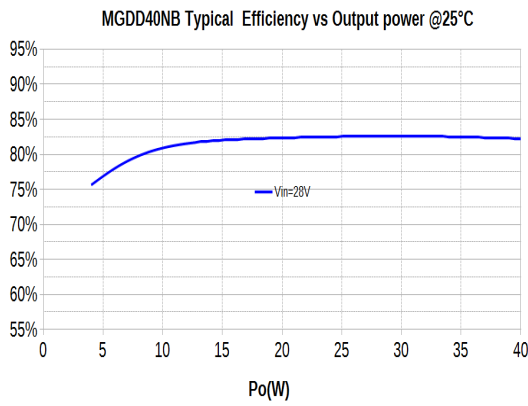

4- Electrical Characteristics (continued)

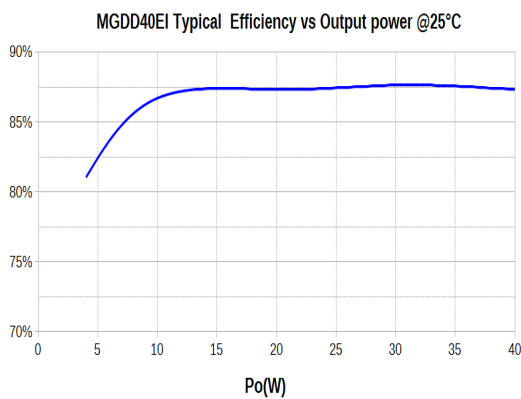
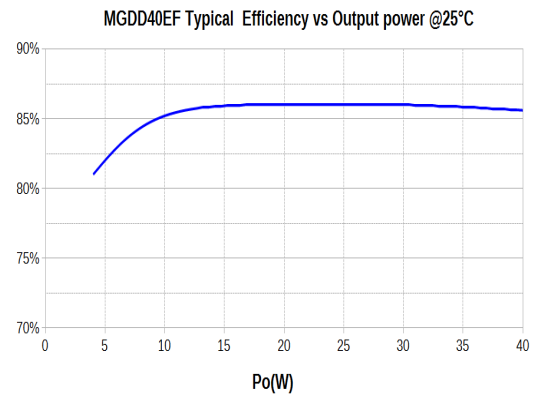
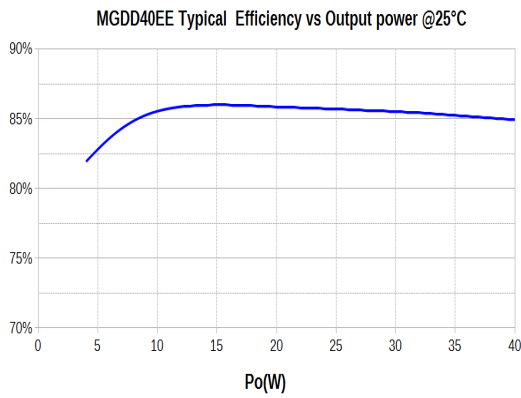
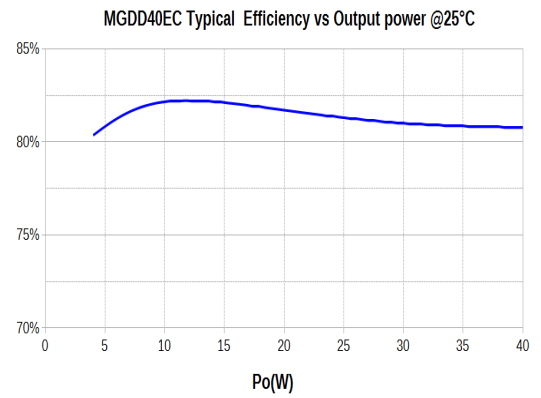
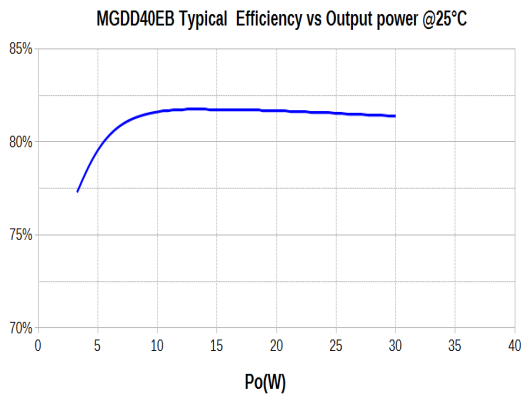

5- Switching Frequency

Characteristics	Conditions	Limit or typical	Specification
Switching frequency	Full temperature range Ui min. to max. No load to full load	Nominal, fixed	330 KHz
Synchronization frequency range	Frequency of external synchronization signal	Minimum Maximum	270 KHz 360 KHz

6- Isolation

Parameters	Conditions	Limit or typical	Specifications
Isolation voltage (Case not connected)	Input to output Between outputs	Minimum Minimum	1 500 Vdc/ 1 min 300 Vdc
Isolation safety rating	Input to output Between outputs	/	Functionnal
Isolation capacitance	Input to input	Typical	1 nF
Isolation resistance	Input to case 500 Vdc Output to case 500 Vdc	Minimum Minimum	100 MOhm 100 MOhm

7- Protection Functions

Characteristics	Protection Device	Recovery	Limit or typical	Specifications
Input undervoltage lock-out (UVLO)	Turn-on, turn-off circuit with hysteresis cycle	Automatic recovery	Turn-on nominal Turn-off nominal	See section 3
Output current limitation protection (OCP)	Straight line current limitation	Automatic recovery	Typical Minimum	160% of Inom. 105% of Inom.

8- Reliability Data

Characteristics	Conditions	Temperature	Specifications
Mean Time Between Failure (MTBF) According to MIL-HDBK-217F	Ground benign (Gb)	Case at 40°C	2 855 000 Hrs
	Ground fixed (Gf)	Case at 40°C Case at 70°C	1 025 000 Hrs 470 000 Hrs
	Airborne, Inhabited Cargo (AIC)	Case at 40°C Case at 70°C	595 000 Hrs 295 000 Hrs
Mean Time Between Failure (MTBF) According to IEC-62380-TR	Aircraft Civilian	Ambient at 25°C 100% time on	Consult factory

9- Electromagnetic Interference and Surge

Electromagnetic Interference requirements according to MIL-STD-461C/D/E/F standards can be easily achieved as indicated in the following section. The following table resumes the different sections covered by these standards.

Standard Requirements	MIL-STD-461C Standard	MIL-STD-461D/E/F Standard	Compliance with GAIA Converter Module & common mode capacitance
Conducted emission (CE) : Low frequency High frequency	CE 01 CE 03	CE 101 CE 102	compliant module stand-alone compliant with additionnal filter
Conducted susceptibility (CS) : Low frequency High frequency	CS 01 CS 02	CS 101 CS114	compliant with additionnal filter compliant with additionnal filter
Radiated emission (RE) : Magnetic field Electrical field	RE 01 RE 02	RE 101 RE 102	compliant module stand-alone compliant module stand-alone
Radiated susceptibility (RS) : Magnetic field Electrical field	RS 01 RS 03	RS 101 RS 103	compliant module stand-alone compliant module stand-alone

9-1 Module Compliance with MIL-STD-461C/D/E/F Standards

To meet the latest US military standards MIL-STD-461 requirements and in particular the conducted noise emission CE102 (and also CE03) requirements, Gaia Converter can propose an EMI filter module. In addition common mode capacitances C_{mc} (10nF/rated voltage depending on isolation requirement) connected between power pins and chassis or ground power-plane need to be implemented. When output channels are intended to be connected to load through long wire, it could be necessary to use additionnaly common mode inductors on each outputs. For a use at 28Vdc C7 can be rated to 47µF.

Please consult FGDS-series datasheets for further details.

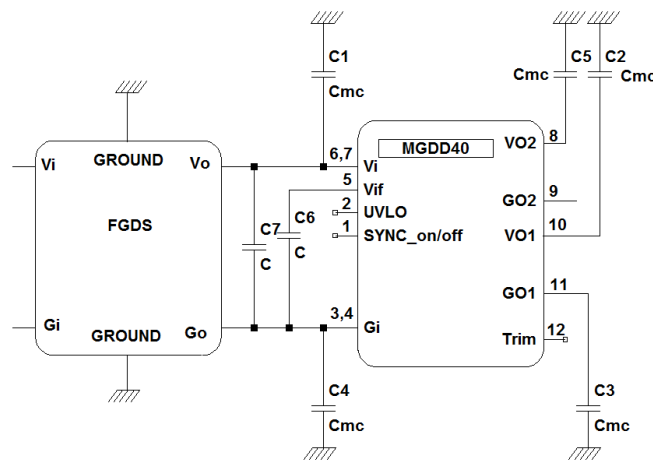

10- Thermal Characteristics

Characteristics	Conditions	Limit or typical	Performances
Operating ambient temperature range	Ambient temperature	Minimum Maximum	- 40°C see below
Operating case temperature range	Case temperature	Minimum Maximum	- 40°C 105°C
Storage temperature range	Non functioning	Minimum Maximum	- 55°C + 125°C

To calculate the maximum ambient temperature at which the converter will be able to operate, the following parameters are required :

- Tcase = maximum case temperature the converter can operate
- Tmax = maximum ambient temperature the converter can operate
- Pout = effective output power used (see also page thereafter curves of maximum power)
- Rth(c) = thermal resistance case to ambient of the converter (see table below) in free air natural convection
- Rth(tot) = thermal resistance of converter and its heatsink (if used)
- Rth(hs) = Thermal resistance of heat sink (if used)
- η = converter efficiency

There are 3 mounting possibilities as described below :

Converter Stand-Alone Mounting

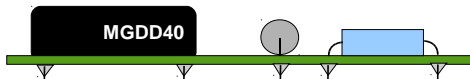

To calculate the maximum ambient temperature at which the converter can operate, the following formula can be applied :

$$T_{max} = T_{case} - R_{th}(c) \times P_{out}(1/\eta - 1)$$

Converter with Chassis Mounting

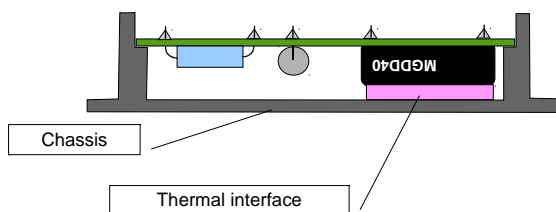

If the thermal interface resistance can be neglected, the maximum chassis temperature is equal to the maximum converter case temperature.

$$T_{max\ chassis} = T_{max}$$

Converter with Heatsink Mounting

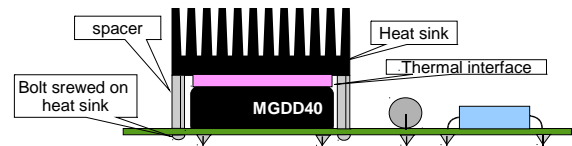

To calculate the maximum ambient temperature the converter can operate, the following formula can be applied :

$$T_{max} = T_{case} - R_{th}(tot) \times P_{out}(1/\eta - 1)$$

The most sensitive parameter in this formula is the Rth(tot) value.

Rth(tot) depends on the thermal resistance of the converter Rth(c) in the mounting configuration and the thermal resistance of the heatsink Rth(hs).

- The Rth(c) depends on ambient temperature, the way the converter is tied to the PCB, position, PCB copper track and power plane length. Also, in general Rth(c) decreases as temperature is increases.

- Rth(hs) : Rth(hs) value is highly depending on how the heatsink is connected to case.

The value of Rth(tot) can be evaluated with the below definition :

$$R_{th}(c) \times R_{th}(hs) / (R_{th}(c) + R_{th}(hs)) < R_{th}(tot) < R_{th}(c)$$

The table hereafter gives some example of thermal resistance for different heat transfert configurations.

Heat transfert	Thermal resistance heatsink to air Rth(h-a)	Conditions	Global resistance
Free air cooling only	Rth(c) : no Heatsink baseplate only	Ambient 60°C, converter on PCB	13.2
	Rth(tot) with heatsink ABL BGA-STD-110 (30 mm x 30 mm)	Ambient 60°C, converter on PCB	< 8.5

10- Thermal Characteristics (continued)

A maximum power for a Tcase of 105°C depending on input voltage is given in the following curves

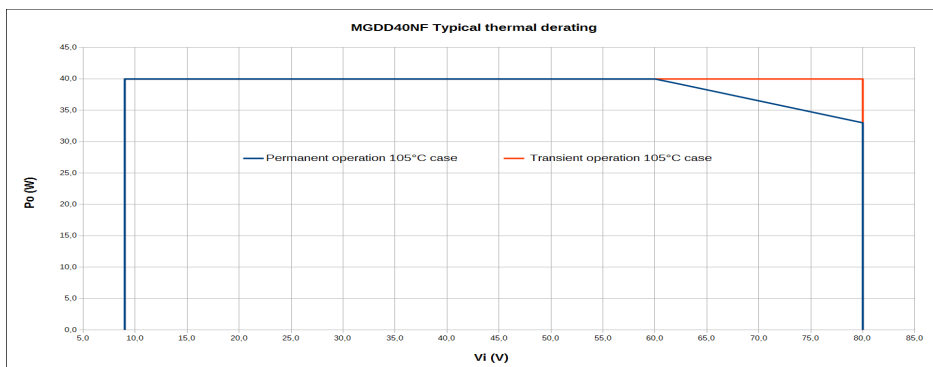
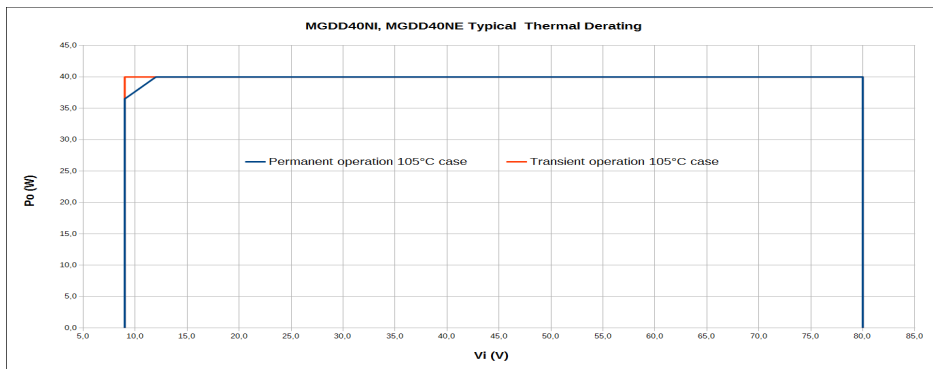
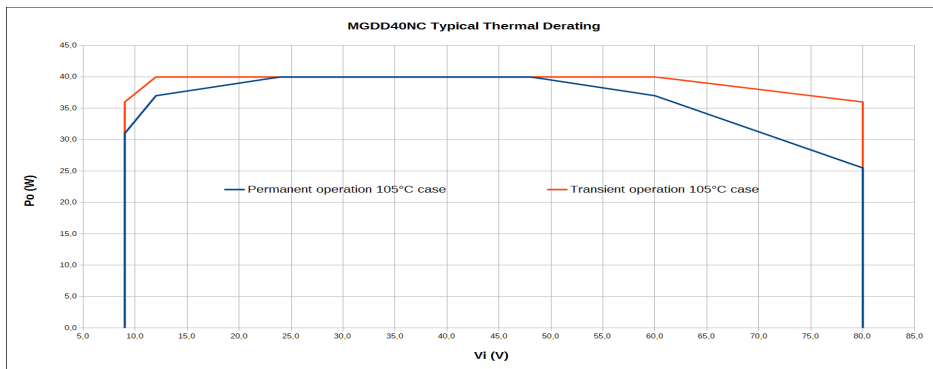
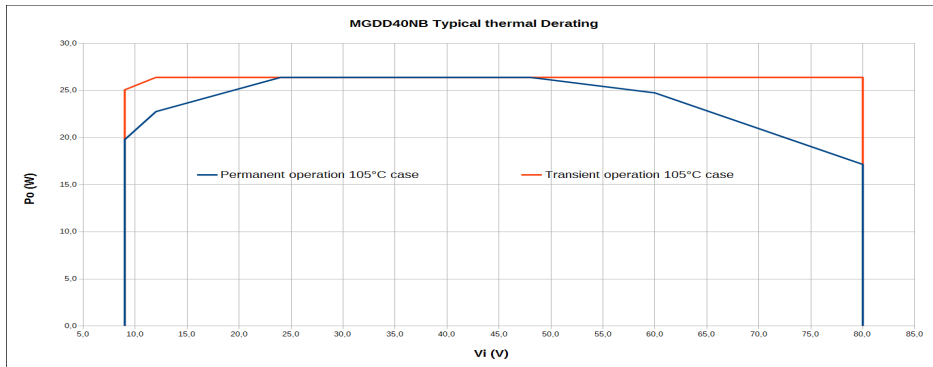

11- Environmental Qualifications

The modules have been subjected to the following environmental qualifications.

Characteristics	Conditions	Severity	Test procedure
Climatic Qualifications			
Life at high temperature	Duration Temperature / status of unit	Test D : 1 000 Hrs @ 105°C case, unit operating @ 125°C ambient, unit not operating	MIL-STD-202G Method 108A
Altitude	Altitude level C Duration Climb up Stabilization Status of unit	40 000 ft@-55°C 30 min. 1 000 ft/min to 70 000 ft@-55°C, 30 min. unit operating	MIL-STD-810E Method 500.3
Humidity cyclic	Number of cycle Cycle duration Relative humidity variation Temperature variation Status of unit	10 Cycle I : 24 Hrs 60 % to 88 % 31°C to 41°C unit not operating	MIL-STD-810E Method 507.3
Humidity steady	Damp heat Temperature Duration Status of unit	93 % relative humidity 40°C 56 days unit not operating	MIL-STD-202G Method 103B
Salt atmosphere	Temperature Concentration NaCl Duration Status of unit	35°C 5 % 48 Hrs unit not operating	MIL-STD-810E Method 509.3
Temperature cycling	Number of cycles Temperature change Transfert time Steady state time Status of unit	200 -40°C / +85°C 40 min. 20 min. unit operating	MIL-STD-202A Method 102A
Temperature shock	Number of shocks Temperature change Transfert time Steady state time Status of unit	100 -55°C / +105°C 10 sec. 20 min. unit not operating	MIL-STD-202G Method 107G
Mechanical Qualifications			
Vibration (Sinusoidal)	Number of cycles Frequency / amplitude Frequency / acceleration Duration Status of unit	10 cycles in each axis 10 to 60 Hz / 0.7 mm 60 to 2 000 Hz / 10 g 2h 30 min. per axis unit not operating	MIL-STD-810D Method 514.3
Shock (Half sinus)	Number of shocks Peak acceleration Duration Shock form Status of unit	3 shocks in each axis 100 g 6 ms 1/2 sinusoidal unit not operating	MIL-STD-810D Method 516.3
Bump (Half sinus)	Number of bumps Peak acceleration Duration Status of unit	2 000 Bumps in each axis 40 g 6 ms unit not operating	MIL-STD-810D Method 516.3

12- Description of Protections

The MGDD-40 series includes 2 types of protection devices.

12-1 Input Undervoltage Lockout (UVLO)

An input undervoltage protection will inhibit the module when input voltage drops below the lock-out turn-off threshold (see section 3 for value) and restores to normal operation automatically when the input voltage rises above the lock-out turn-on threshold.

The UVLO voltage can be adjusted using an external resistor (R_{uvlo}) connected between pin 2 and G_i . This value can be adjusted in order to allow converter to shut down properly depending on the input bus (or battery) voltage value. R_{uvlo} can be determined using the following formula

$$R_{uvlo} (K\Omega) = \frac{A}{V_{uvlo} - B} - 1$$

R_{uvlo} = trimming resistance

V_{uvlo} = desired turn-on voltage

A & B = input range parameter (see table below)

Converter Series	Parameter A	Parameter B
MGDD-40-N Series	110	8.51
MGDD-40-E Series	41	3.69

Values are in KOhms

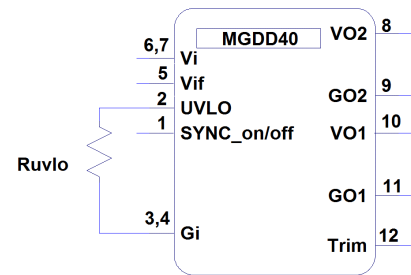
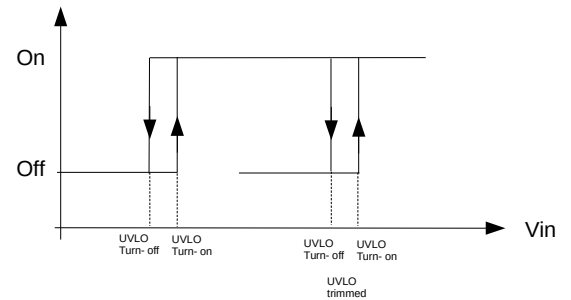

4

12-2 Output Over Current Protection (OCP)

The MGDD-40 Series incorporates an over-current protection circuit that detects short circuit or over current and protects the module according to the hiccup graph .

The maximum detection current I_d is depending on input voltage V_{in} and temperature. When OCP is triggered, the converter falls into hiccup mode, testing periodically if the overload is still present. The module restart automatically in soft-start to normal operation when overcurrent is removed. T_d (detection time) and T_h (hiccup period) are depending on V_{in} and temperature.

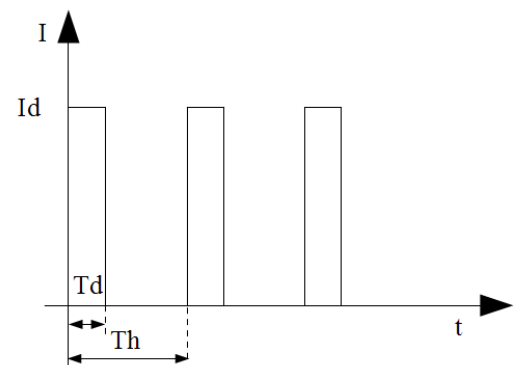

13- Description of Functions

13-1 Connection of Outputs

The outputs of MGDD-40 can be connected in various configurations such as :

- connections in series
- connection in parallel (not applicable for MGDD-40-NCE)
- connection in symmetry
- connection in independence

Please note that regulation is achieved through output V01/G01 referenced as primary output. When connected in symmetry or independent configurations with unbalanced loads, V01/G01 has to be loaded at 4W minimum to insure proper operation of the converter.

V02/G02 limits :

The V02/G02 output referenced as secondary output may stay unloaded but in that case its regulation may drift-up. V02 drift increases with V01 load and can reach up to 130% (typical) of V02 nominal voltage in worst case. A 10% load on V02 will bring back the drift within lower values as per graph.

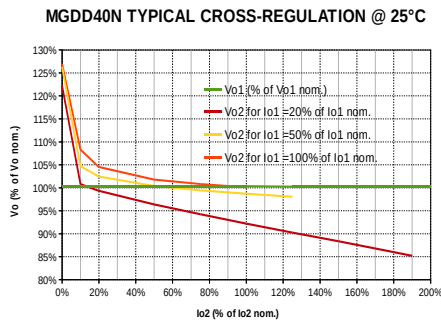

Vo2 regulation versus current Io2 as % of nominal Io2nom @ V01 various fixed load as a % of nominal current Io1nom

13-1-1 Connection of Outputs in Series

Outputs connected in series allow to achieve 6,6V, 10V, 24V, 30V or 48V output voltages up to 40W total power. These values can be extended using trim adjustment.

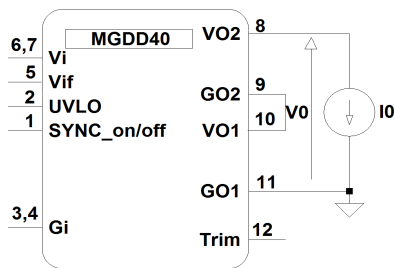

13-1-2 Connection of Outputs in Parallel

Outputs connected in parallel allow to achieve single output 3,3V, 5V, 12V, 15V or 24V up to 40W power. These values can be extended using trim adjustment.

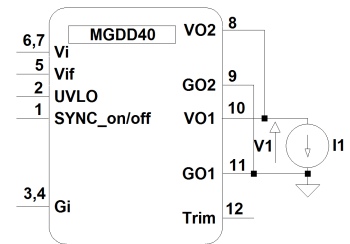

13-1-3 Connection of Outputs in Symmetry

Outputs connected in symmetry allow to achieve +/-5V, +/-12V, +/-15V or +/-24V voltages (+/-20W on each channel) with possible unbalanced load up to 34W on output 1, 6W on output 2 and vice versa.

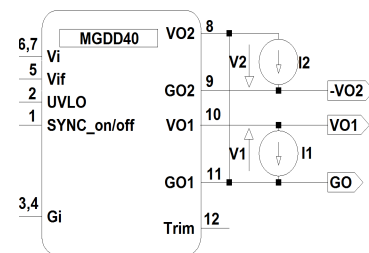

13-1-4 Connection of Outputs in Independence

Outputs connected independently with floating voltage between each other can be achieved for 2x3,3V, 2x5V, 2x12V, 2x15V or 2x24V voltages (20W each) with possible unbalanced load up to 34W on output 1, 6W on output 2 and vice versa.

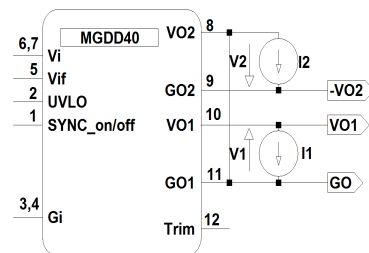

13- Description of Functions (continued)

13-2 Trim Function

The output voltage Vo1 may be trimmed in a range of 80% to 110% of the nominal output voltage (100%/110% for 3,3 Vdc output voltage) via a single external trimpot or fixed resistor.

The VO2 output will be automatically trimmed to the same value as VO1, whatever the outputs combination is.

Trim Up Function

Do not attempt to trim the module higher than 110% of nominal output voltage as the overvoltage protection may trigger.

Also do not exceed the maximum rated output power when the module is trimmed up.

The trim up resistance must be calculated with the following formula :

$$R_U (k\Omega) = 4,7 \cdot \frac{VO_{nom} - 1,225}{VO - VO_{nom}} - 0,27$$

R_u is the trim resistor value in KOhm
 VO_{nom} is the nominal output voltage 1
 VO is the desired trimmed output voltage

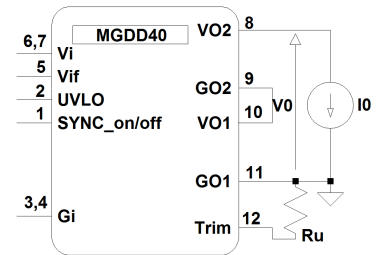

Trim Down Function

Do not trim down more than -20% of nominal output voltage otherwise the module may be damaged.

The available output power is reduced by the same percentage that the output voltage is trimmed down.

The trim down resistance must be calculated with the following formula :

$$R_D (k\Omega) = 4,7 \cdot \left(\frac{VO_{nom}}{1,225} - 1 \right) \cdot \frac{VO - 1,225}{VO_{nom} - VO} - 0,27$$

R_d is the trim resistor value in KOhm
 VO_{nom} is the nominal output voltage 1
 VO is the desired trimmed output voltage

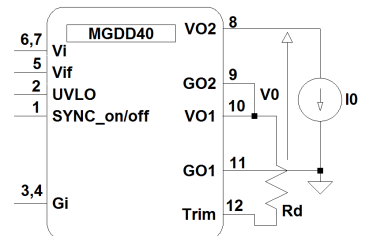

13- Description of Functions (continued)

13-3 On/Off (SYNC_On/Off) Function

The control pin 1 (SYNC_On/Off) can be used for applications requiring On/Off operation. This may be done with an open collector transistor, a switch, a relay or an optocoupler. Several converters may be disabled with a single switch by connecting all SYNC_On/Off pins together.

- The converter is disabled by pulling low pin 1.
- No connection or high impedance on pin 1 enables the converter.

By releasing the On/Off function, the converter will restart within the start up time specifications given in table section 3

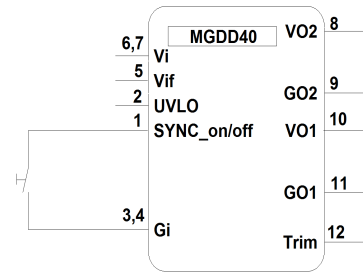

Parameter	Unit	Min.	Typ.	Max.	Notes, conditions
On/Off module enable voltage	Vdc	2.5	/	3.3	Open, the switch must not sink more than 50μA
On/Off module disable voltage	Vdc	0	/	0.5	The switch must be able to sink 0,5mA
On/Off module enable delay	ms	/	/	30	The module restarts with the same delay after alarm mode removed
On/Off module disable delay	μs	/	/	100	Vi nominal, full load

13-4 Synchronization (SYNC_On/Off) Function

The MGDD-40 voltage series provides an external synchronization function through the SYNC-On/Off pin. SYNC-On/Off pin is an input only and is referenced to Gi. Automatic synchronization of multiple units (all Sync pins connected) is not possible.

This pin can be driven directly by using a LV TTL (3,3V) gate. SYNC_On/Off pin is internally pulled up to 3V (logic level 1). It is possible to synchronize the module by using totem pole stage (transistor, optocoupler, ...). Minimum 3,3V LV TTL rise time (t_r) and fall time (t_f) are 20ns. The module can lock on frequency above or below its free-run frequency $2.52 \mu s < T_{sync} < 3.78 \mu s$ and $0.3 \mu s < T_p < 2.7 \mu s$.

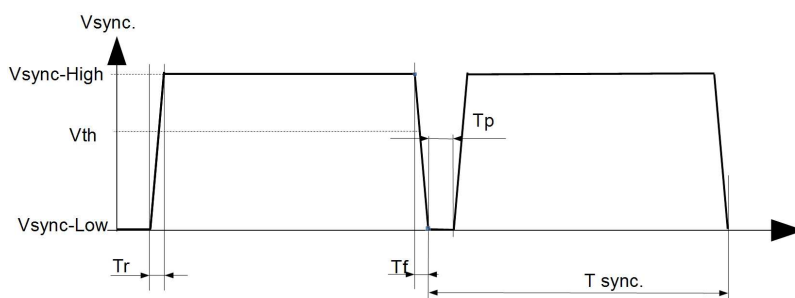
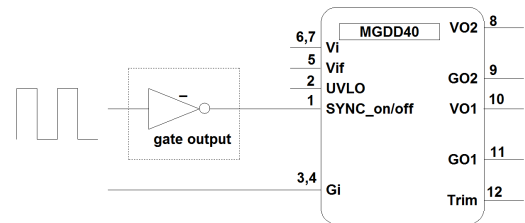

13-5 Input Filter Compensation (VIF)

The «VIF» pin is a direct access to the capacitor of the internal LC input filter. For stringent application it is possible to improve the converter stability and to reduce the input current ripple for better EMI performance, by adding a capacitor across «VIF» pin and «Gin» pin.

This capacitor should have the proper voltage rating compatible with the input range. Because of high current flowing through it, it should be of ceramic type and connected between «VIF» and «Gin» as close as possible.

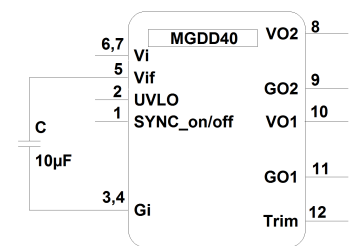

14- Dimensions

Dimension are given in mm. Tolerance : +/- 0,2 mm (+/- 0.01 ") unless otherwise indicated.
 All dimensions specified "Min" or "Max" are subjected to tolerance Min^{+0,5/-0mm} and Max^{+0/-0,5mm}.
 Weight : 40 grams (0,7 Ozs) max.

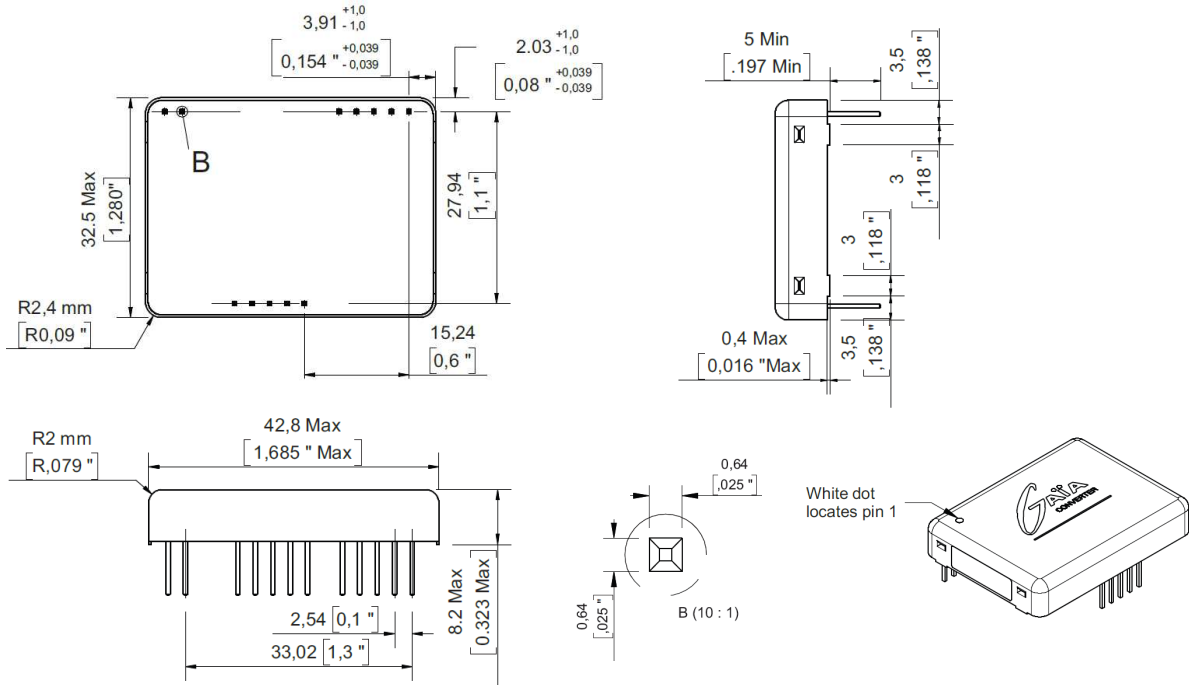

15- Materials

Case : Metallic black anodized coating.
 Pins : Flash gold plating over nickel underplate.

16- Product Marking

Upper face : Company logo.
 Side face : Module reference, option, date code : year and week of manufacturing.

17- Connections

The MGDD-40 series has been designed for on-board mounting.
 it is recommended not to lay-out any component under the module.

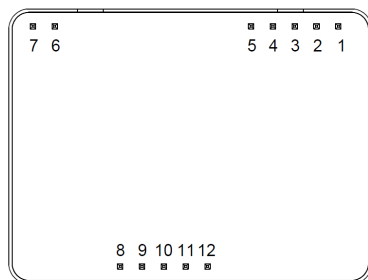

Bottom view

Pin	Dual
1	Sync-SD
2	UVLO
3	- Input (Gi)
4	- Input (Gi)
5	VIF
6	+ Input (Vi)
7	+ Input (Vi)
8	+ Output 2 (Vo2)
9	- Output 2 (Go2)
10	+ Output 1 (Vo1)
11	- Output 1 (Go1)
12	Vtrim



Represented by :

Information given in this datasheet is believed to be accurate and reliable. However, no responsibility is assumed for the consequence of its use nor for any infringement of patents or other rights of third parties which may result from its use. These products are sold only according to GAIA Converter general conditions of sale, unless otherwise confirmed by writing. Specifications subject to change without notice.